

PTS 2 / PTS 3

2016 CHANNEL REFRESH STYLE GUIDE



Creative Director: JL
Executive Producer: Angela Moo
Art Director: Lance Wei
Designer: Julian Chen

| | |
|---------|--------------------------|
| 03 — 04 | 頻道識別 / IDENTITY |
| 05 — 07 | 顏色 / COLOR PALATTE |
| 08 — 09 | 字體 / TYPOGRAPHY |
| 10 — 24 | 主控鏡面 / ON-SCREEN GRAPHIC |
| 25 — 27 | 節目表 / MENU |
| 28 — 37 | 節目宣傳包裝 / PROMO PACKAGE |
| 38 — 39 | 節目提示卡 / NEXT |
| 40 | 資訊插卡 / ANNOUNCEMENT |
| 41 | 警示卡 / WARNING LABELS |
| 42 — 43 | 節目分級卡 / PROGRAM RATING |

LOGO - PTS 2

SOLID COLOR
FOR PRINT



GRADIENT COLOR
FOR BOTH BROADCAST AND PRINT



LOGO - PTS 3

SOLID COLOR
FOR PRINT



GRADIENT COLOR
FOR BOTH BROADCAST AND PRINT



IDENTITY COLOR

SOLID
COLOR



| | | | | | | | | |
|------|------|-----|------|-----|-----|-----|-----|------|
| R249 | G166 | B74 | R232 | G36 | B41 | R7 | G82 | B156 |
| C0 | M40 | | C3 | M98 | | C98 | M76 | |
| Y80 | K0 | | Y94 | K0 | | Y7 | K0 | |

GRADIENT
COLOR



| | | | | | | | | |
|------|------|-----|------|-----|-----|-----|------|------|
| R249 | G192 | B74 | R237 | G58 | B41 | R20 | G101 | B174 |
| R249 | G166 | B74 | R232 | G36 | B41 | R7 | G82 | B156 |
| R247 | G145 | B59 | R192 | G15 | B28 | R18 | G63 | B169 |

EXTENDED
GRADIENT
COLOR



| | | | | | | | | |
|------|------|------|------|-----|-----|-----|------|------|
| R254 | G199 | B95 | R225 | G33 | B33 | R36 | G105 | B180 |
| R253 | G113 | B52 | R149 | G0 | B0 | R7 | G38 | B119 |
| R254 | G225 | B111 | R245 | G71 | B59 | R67 | G151 | B217 |
| R252 | G134 | B58 | R192 | G15 | B28 | R43 | G87 | B178 |

PROMO COLOR

SPORTS



| | | |
|------|------|-----|
| R248 | G161 | B93 |
| R244 | G120 | B73 |
| R239 | G78 | B52 |



DOCUMENTARY

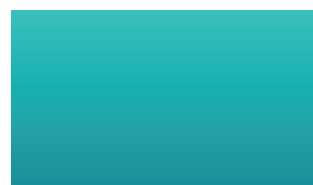

| | | |
|-----|------|------|
| R66 | G191 | B188 |
| R24 | G173 | B176 |
| R17 | G139 | B151 |



TEEN



| | | |
|------|------|-----|
| R202 | G214 | B59 |
| R153 | G196 | B64 |
| R104 | G178 | B69 |



DRAMA



| | | |
|------|------|------|
| R219 | G125 | B201 |
| R175 | G84 | B176 |
| R155 | G77 | B183 |



ART



| | | |
|------|------|------|
| R253 | G117 | B123 |
| R252 | G60 | B107 |
| R202 | G22 | B81 |



LIVING





| | | |
|------|------|------|
| R100 | G197 | B228 |
| R71 | G178 | B220 |
| R40 | G139 | B203 |





PROGRAM RATING COLOR

普遍級









| | | | |
|------|------|-----|---|
| R206 | G219 | B92 |  |
| R162 | G202 | B84 |  |
| R113 | G181 | B71 |  |

| | | | |
|------|------|-----|---|
| R168 | G203 | B82 |  |
| R113 | G175 | B65 |  |
| R79 | G151 | B50 |  |

保護級









| | | | |
|-----|------|------|---|
| R72 | G178 | B226 |  |
| R65 | G152 | B216 |  |
| R56 | G120 | B203 |  |

| | | | |
|-----|------|------|---|
| R62 | G158 | B218 |  |
| R49 | G122 | B202 |  |
| R39 | G94 | B190 |  |

輔導級







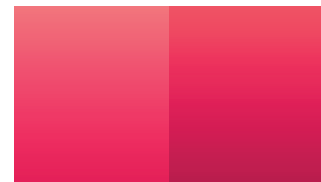

| | | | |
|------|------|-----|---|
| R246 | G175 | B86 |  |
| R250 | G127 | B76 |  |
| R247 | G84 | B59 |  |

| | | | |
|------|------|-----|---|
| R240 | G152 | B79 |  |
| R235 | G100 | B60 |  |
| R227 | G61 | B44 |  |

限制級



| | | | |
|------|------|------|---|
| R253 | G120 | B125 |  |
| R248 | G66 | B105 |  |
| R226 | G35 | B87 |  |

| | | | |
|------|-----|-----|---|
| R252 | G82 | B99 |  |
| R226 | G41 | B89 |  |
| R183 | G10 | B74 |  |

星期一至五

23:00

2012

美國網球公開賽

2012 US Open

蘋果儷中黑

0123456789 星期一至五美國網球公開賽

ITC OFFICINA SANS STD BOLD ITALIC

***0123456789AaBbCcDdEeFfGgHhIiJjKk
LlMmNnOoPpQqRrSsTtUuVvWwXxYyZz***

ITC OFFICINA SANS STD REGULAR

0123456789AaBbCcDdEeFfGgHhIiJjKk
LlMmNnOoPpQqRrSsTtUuVvWwXxYyZz

FOR PC FONTS

星期一至五

23:00

2012

美國網球公開賽

2012 US Open

華康儷中黑

0123456789 星期一至五美國網球公開賽

ARIAL BOLD ITALIC

**0123456789AaBbCcDdEeFfGgHhIiJjKk
LIMmNnOoPpQqRrSsTtUuVvWwXxYyZz**

ARIAL REGULAR

0123456789AaBbCcDdEeFfGgHhIiJjKk
LIMmNnOoPpQqRrSsTtUuVvWwXxYyZz

PTS 2 ON-SCREEN LOGO

彩色



白色



PTS 2 ON-SCREEN LOGO

左標

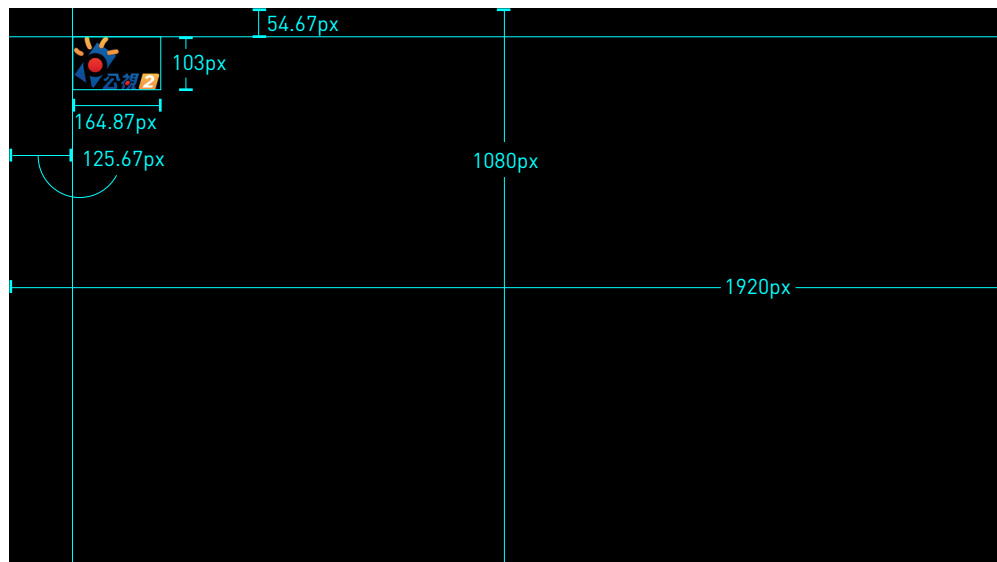

右標

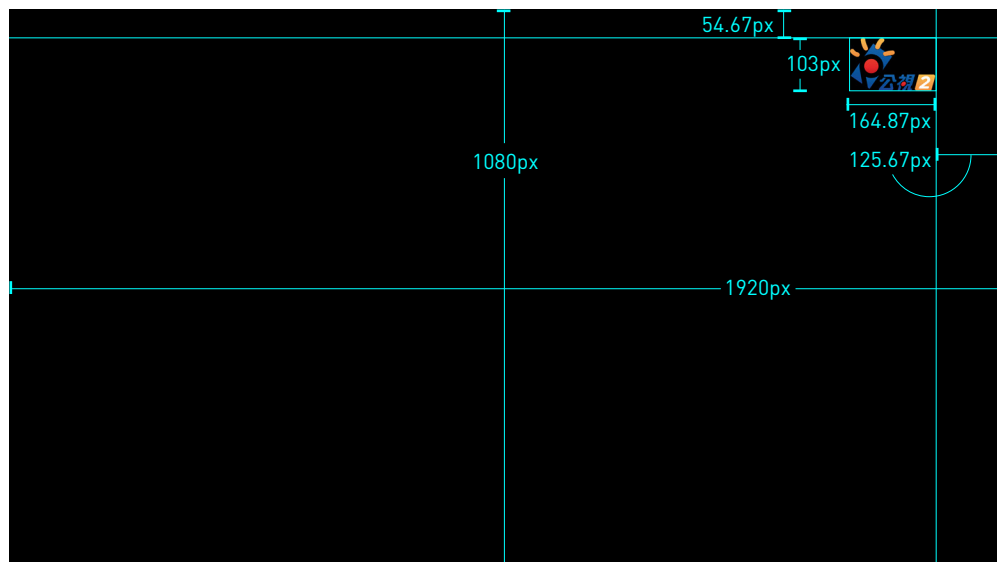

PTS 2 ON-SCREEN LOGO

彩色



白色



PTS 2 側標

LIVE



重播



PTS 2 側標

雙語



立體聲



PTS 2 側標

環繞



3D



PTS 3 ON-SCREEN LOGO

彩色



白色



PTS 3 ON-SCREEN LOGO

左標

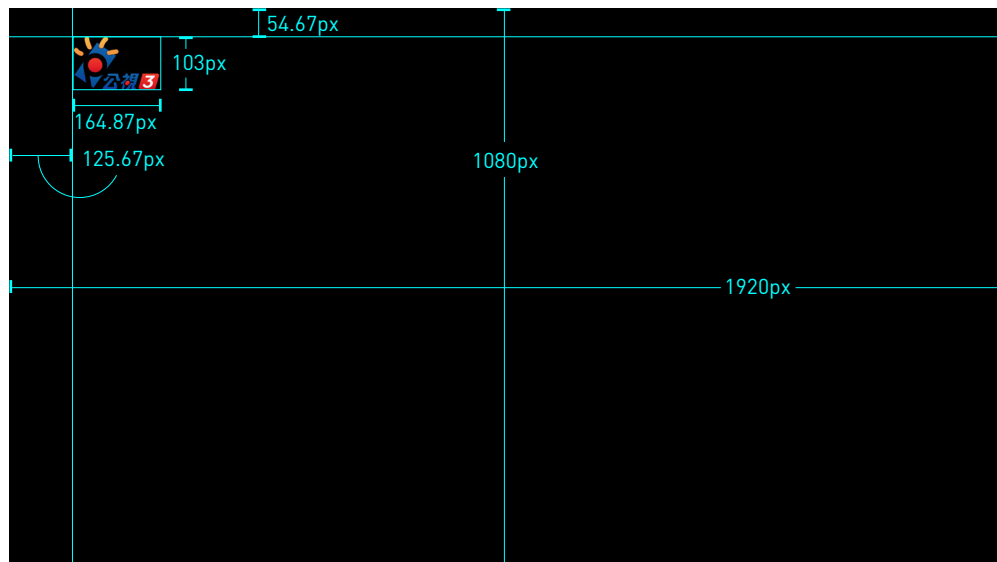

右標

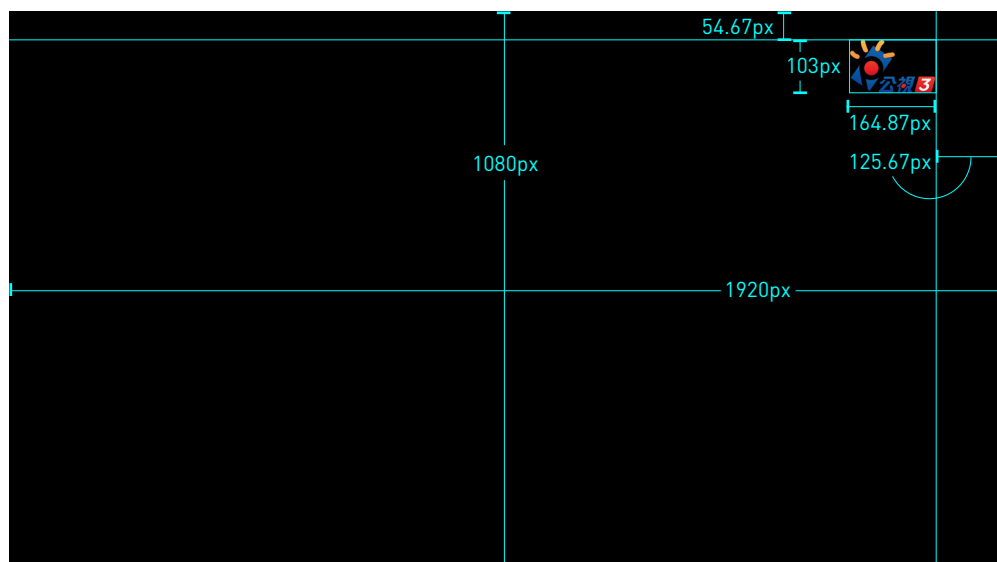

PTS 3 ON-SCREEN LOGO

彩色



白色



PTS 3 側標

LIVE



重播



PTS 3 側標

雙語



立體聲



PTS 3 側標

環繞



3D



NEXT ON 10"



SHORT VERSION



LONG VERSION

NEXT ON 10"



SHORT VERSION



LONG VERSION

NEXT ON 10"



RIGHT EXAMPLE



WRONG EXAMPLE

字體顏色使用錯誤。

MENU 15"



The image displays four program schedule cards arranged in a 2x2 grid. Each card features a background image and a blue semi-circular overlay at the bottom containing program information. The top-left card shows a basketball player's face through a stylized blue and white graphic. The top-right card shows hands reaching for a basketball. The bottom-left card shows a close-up of two men's faces. The bottom-right card shows a man and a woman smiling together. The text on the cards is as follows:

| Time | Program Name | English Title |
|-------|------------------|-----------------------------|
| 21:00 | 第34屆威廉瓊斯盃國際籃球邀請賽 | The 34th William Jones' Cup |
| 22:00 | 危險邊緣 第二季 | Fringe season 2 |
| 23:00 | 愛。回來 | Way Back Into Love |



節目A圖片
圖檔須大於1920 x 1080px

今晚

21:00
第34屆威廉瓊斯盃
國際籃球邀請賽
The 34th William Jones' Cup
節目A

22:00
危險邊緣
第二季
節目B

23:00
愛。回來
Way Back Into Love
節目C

節目時段 蘋果儷中黑 斜體 224px
時間 ITC OFFICINA SANS STD BOLD ITALIC 98px
中文節目單元 蘋果儷中黑 一行8個字元以內 50px
英文節目名稱 ITC OFFICINA SANS STD REGULAR 36px

今晚

時間 ITC OFFICINA SANS STD BOLD ITALIC 53px
中文節目單元 蘋果儷中黑 一行8個字元以內 34px
英文節目名稱 ITC OFFICINA SANS STD REGULAR 25px

節目B圖片
圖檔須大於1920 ×1080px

| | | |
|--|--|--|
| 21:00 第34屆威廉瓊斯盃 國際籃球邀請賽 The 34th William Jones Cup 節目A | 22:00 危險邊緣 第二季 Fringe season 2 節目B | 23:00 愛。回來 Way Back Into Love 節目C |
|--|--|--|

今晚

節目C圖片
圖檔須大於1920 ×1080px

| | | |
|--|--|--|
| 21:00 第34屆威廉瓊斯盃 國際籃球邀請賽 The 34th William Jones Cup 節目A | 22:00 危險邊緣 第二季 Fringe season 2 節目B | 23:00 愛。回來 Way Back Into Love 節目C |
|--|--|--|

6 THEMES

SPORTS
運動賽事



TEEN
兒童青年



ART
文化藝術



6 THEMES

DOCUMENTARY

紀錄片



DRAMA

戲劇電影



LIVING

生活休閒



6 THEMES

SPORTS 運動賽事



DOCUMENTARY 紀錄片



TEEN 兒童青年



DRAMA 戲劇電影



ART 文化藝術



LIVING 生活休閒



PROMO PACKAGE 15"-22"

OPENER 3-4"



LOWER THIRD 5-10"



SHORT VERSION



LONG VERSION

ENDPAGE 5-6"



LOGO PAGE 2"



OPENER 3-4"

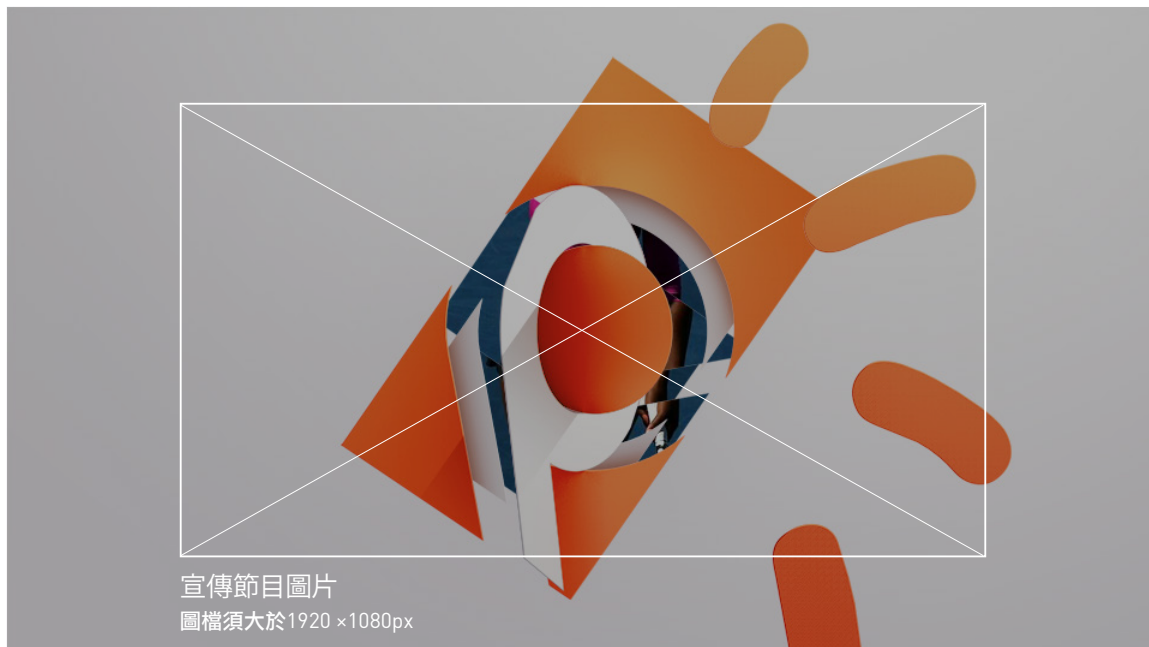

OPENER 3-4"

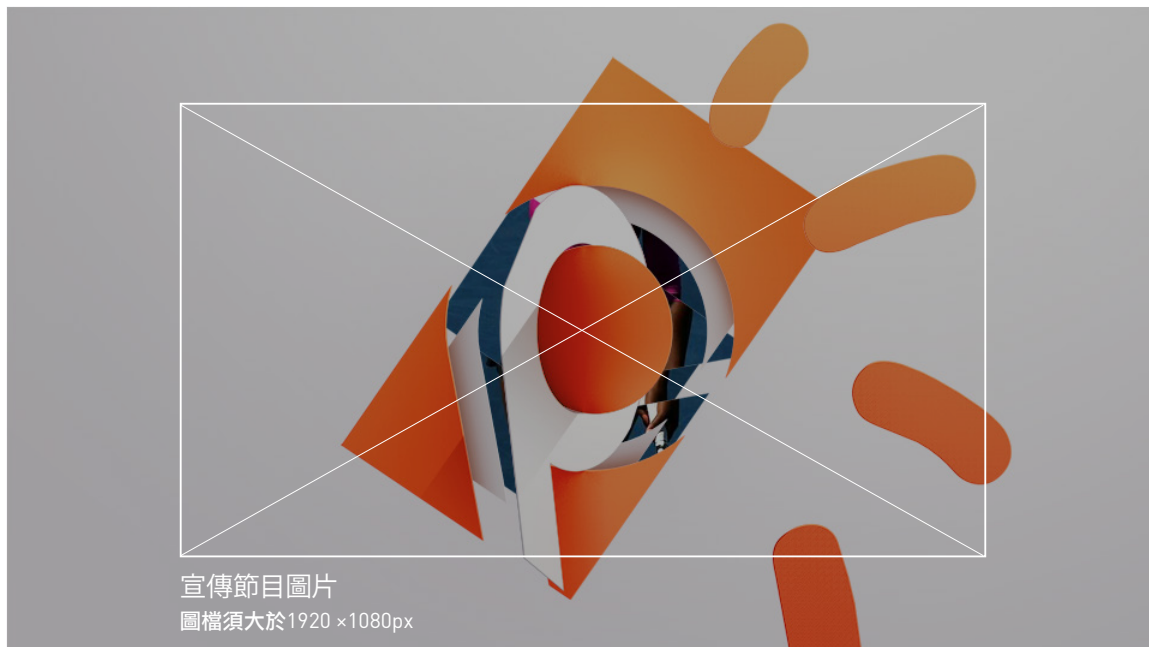

OPENER 3-4"



LOWER THIRD 5-10"



SHORT VERSION



LONG VERSION

LOWER THIRD 5-10"



RIGHT EXAMPLE



WRONG EXAMPLE

「台北國際合唱音樂節」的節目屬性為藝術與文化，應該使用桃紅色而不是代表運動賽事的橘色。

END PAGE 5-6"

宣傳節目圖片
圖檔須大於1920 x1080px

日期 蘋果儷中黑 60px

時間 ITC OFFICINA SANS STD BOLD ITALIC 113px

節目企劃單元 蘋果儷中黑 8個字元以內 48px

中文節目名稱 蘋果儷中黑 一行7個字元以內 71px
行距 81px

英文節目名稱 ITC OFFICINA SANS STD REGULAR 50px

節目播放資訊
星期一至五
23:00

118px

2012
美國網球公開賽
2012 US Open

時間 與 中文節目名稱 的距離固定

EXAMPLE 1

宣傳節目圖片
圖檔須大於1920 x1080px

日期 蘋果儷中黑 60px

時間 ITC OFFICINA SANS STD BOLD ITALIC 113px
行距 98px

節目企劃單元 蘋果儷中黑 8個字元以內 48px

中文節目名稱 蘋果儷中黑 7個字元以內 71px

英文節目名稱 ITC OFFICINA SANS STD REGULAR 50px

節目播放資訊
星期五
11:00, 15:00
23:00

118px

紀錄觀點
歸途列車
Last Train Home

時間 與 中文節目名稱 的距離固定

EXAMPLE 2

END PAGE 5-6"

宣傳節目圖片
圖檔須大於1920 ×1080px

日期 蘋果儷中黑 60px

時間 ITC OFFICINA SANS STD BOLD ITALIC 113px

節目企劃單元 蘋果儷中黑 8個字元以內 40px

中文節目名稱 蘋果儷中黑 一行10個字元以內 60px
行距 70px

英文節目名稱 ITC OFFICINA SANS STD REGULAR 40px

節目播放資訊

星期六

23:05,03:00

公視表演廳

台北國際合唱音樂節一
十二生肖

Taipei International
Choral Festival

時間 與 中文節目名稱 的距離固定

118px

EXAMPLE 3

若是節目名稱多於 14 字元, 請使用此 EXAMPLE 字體大小設定。節目名稱至多 20 字元。

NEXT 10"





EXAMPLE 1



EXAMPLE 2

若是節目名稱多於 16 字元, 請使用此 EXAMPLE 字體大小設定。節目名稱至多 20 字元。

ANNOUNCEMENT 15"-30"

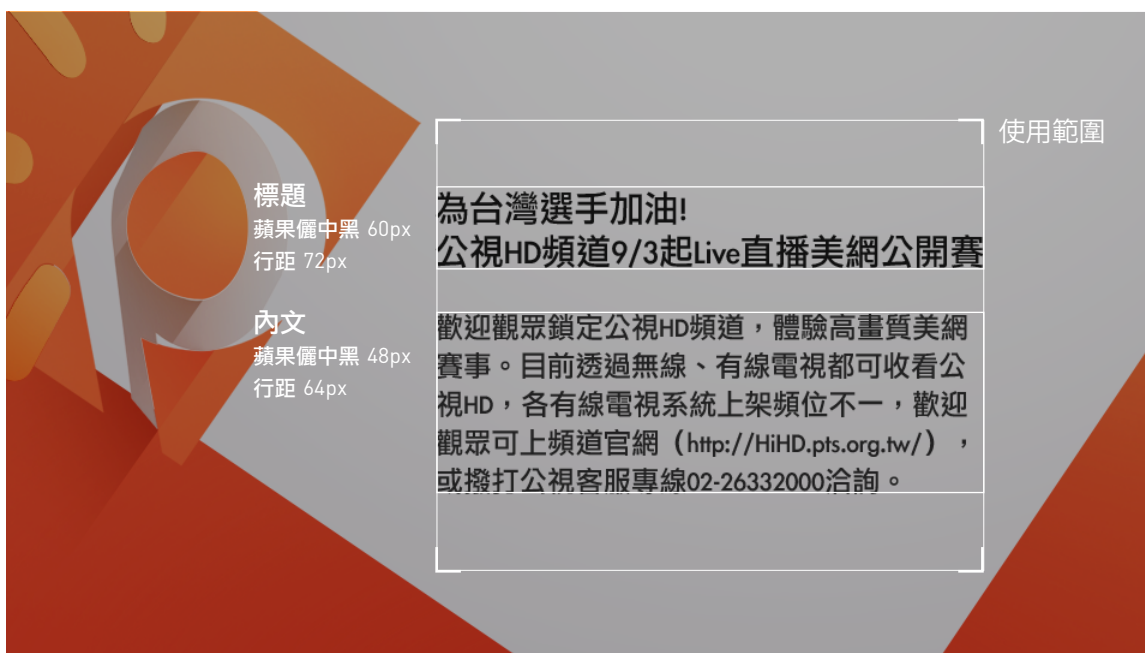

WARNING LABEL 10"

吸菸警示卡



警示卡

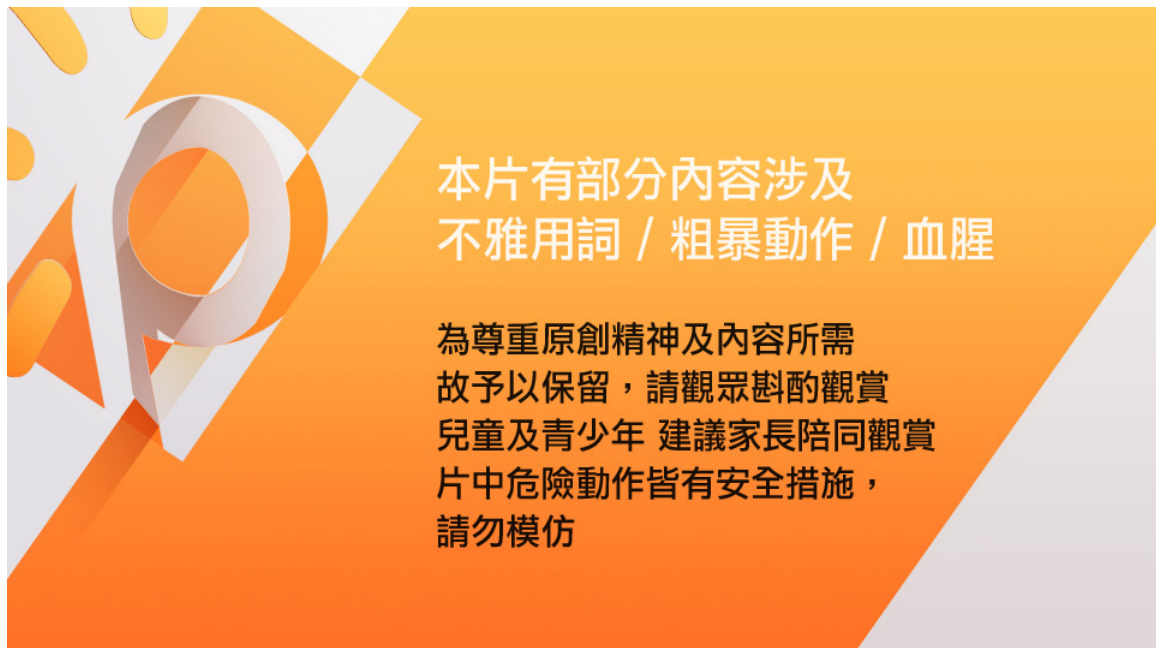

PROGRAM RATING 10''

限制級



輔導級



保護級



普遍級

